

# 1

## Refinery and Petrochemical Processes

### 1.1 Introduction

The combination of high demand for electric cars and higher automobile engine efficiency in the future will mean less conversion of petroleum into fuels. However, the demand for petrochemicals is forecast to rise due to the increase in world population. With this, it is expected that modern and more innovative technologies will be developed to serve the growth of the petrochemical market.

In a refinery process, petroleum is converted into petroleum intermediate products, including gases, light/heavy naphtha, kerosene, diesel, light gas oil, heavy gas oil, and residue. From these intermediate refinery product streams, several fuels such as fuel gas, liquefied petroleum gas, gasoline, jet fuel, kerosene, auto diesel, and other heavy products such as lubricants, bunker oil, asphalt, and coke are obtained. In addition, these petroleum intermediates can be further processed and separated into products for petrochemical applications.

In this chapter, petroleum will be introduced first. Petrochemicals will be introduced in the second part of the chapter. Petrochemicals – the main subject of this book – will address three major areas, (i) the production of the seven cornerstone petrochemicals: methane and synthesis gas, ethylene, propylene, butene, benzene, toluene, and xylenes; (ii) the uses of the seven cornerstone petrochemicals, and (iii) the technology to separate petrochemicals into individual components.

### 1.2 Petroleum

Petroleum is derived from the Latin words “petra” and “oleum,” which means “rock” and “oil,” respectively. Petroleum also is known as crude oil or fossil fuel. It is a thick, flammable, yellow-to-black mixture of gaseous, liquid, and solid hydrocarbons formed from the remains of plants and animals. Over millions of years, this organic mixture of plants and animals was subjected to enormous pressure and heat as layers of earth further buried them over time. The organic mixture changed chemically and broke down into hydrocarbons. Because of the time it takes to form petroleum, it is referred to as a nonrenewable energy source.

### 1.2.1 Forms of Petroleum

Petroleum can be in gas, liquid, and solid forms of hydrocarbons. The forms of petroleum are functions of pressure, temperature, and other surrounding conditions such as rock and soil. Under low surface pressure and temperature conditions, lighter hydrocarbons such as methane, ethane, propane, and butane occur as gases, while heavier hydrocarbons such as octane, benzene, xylenes, and paraffin wax are in the form of liquids or solids. However, in an underground oil reservoir where pressures are high, the proportions of gas, liquid, and solid depend on subsurface conditions. It is expected that there are higher percentages of solids and liquids compared to gas at higher pressures.

#### 1.2.1.1 Gaseous Petroleum: Gaseous Petroleum Can Be Defined as Natural Gas or Shale Gas

Natural gas is a mixture consisting primarily of methane, but also commonly includes varying amounts of other higher alkanes, and small percentages of carbon dioxide, nitrogen, hydrogen sulfide, and helium [1]. Natural gas is found in deep underground reservoirs with sandstone and associated with other hydrocarbon reservoirs.

Shale gas has the same composition as natural gas, except that it is found trapped within shale formations [2]. Shale gas wells depend on hydraulic fractures to allow the gas to flow from the rock and have become an increasingly important source of natural gas in the United States since the start of this century. In 2000, shale gas provided only 1% of U.S. natural gas production; by 2010 it was more than 20%. Today, the United States is the largest shale gas producer in the world [3], while China is estimated to have the world's largest shale gas reserves [4].

#### 1.2.1.2 Liquid Petroleum: Liquid Petroleum Can Be Separated into Light Crude Oil and Heavy Crude Oil

Light crude oil has a low viscosity and is a liquid at room temperature. These properties make light crude oil easy to pump and extract. It is composed of short-chain paraffins, which are straight and branched-chain hydrocarbons. Because virgin light crude oil comprises these short chains, it does not have to be heavily refined to produce gasoline. Typically, the chain-length range in gasoline is 4–12 carbons, making light oil a desirable crude to be processed in a refinery. Approximately 30% of the world's petroleum reserves is light oil crude.

Heavy crude has a higher viscosity, but is still a liquid at room temperature. It usually contains more sulfur, nitrogen, and other contaminants than light oil. To refine heavy oil to gasoline, it must be cracked and treated to remove the contaminants. It requires more energy input and cost. Beyond the need for additional refinement, heavy crude also needs additional extraction techniques to recover oil from the wells. These techniques include steam stimulation to make the oil less viscous and the injection of air into the wells to create fires that burn heavier hydrocarbons and degrade them into lighter, more easily pumped compositions.

The transport of heavy oil requires the addition of diluting agents, particularly in pipelines. The other major drawback to heavy crude is its environmental impact because it contains sulfur and heavy metals, both of which must be removed.

Heavy metals are often toxic and their removal from crude presents disposal issues. Sulfur, which may be as high as 4.5 wt%, is corrosive to pipeline metal and refinery components.

### 1.2.1.3 Solid Petroleum: Bitumen

Bitumen is a naturally occurring solid hydrocarbon that generally contains a mixture of large polycyclic aromatic with exceptionally low hydrogen-to-carbon ratios. Bitumen crude is found impregnated in sedimentary rock, which is mainly located in Canada. This rock is often referred to as oil sand or tar sand. Bitumen will not flow unless heated or mixed with lighter crudes to reduce viscosity. Most bitumen extraction processes require some level of physical mining as opposed to pump extraction as with gaseous and liquid crude oil.

When crude oil prices increase, it can become profitable to upgrade bitumen to synthetic crude for fuel. Bitumen can also be used for a number of other purposes, including mortar between bricks, base material for statues, and waterproofing. Today, the largest use of bitumen is roofing applications and at a lower concentration in roadways.

## 1.2.2 Composition of Petroleum

In general, oil wells produce predominantly liquid petroleum (crude oil), with some dissolved natural gas. Because the pressure is lower at the Earth's surface than deep underground, some of the natural gas will come out of the solution and be recovered. Furthermore, at the higher deep underground temperatures and pressures, the dissolved gas may contain heavier hydrocarbons such as pentane, hexane, and heptane. Once these heavier gases reach the lower pressure and temperature surface conditions, they will condense out of the gas phase to form condensate, which has similar appearance to gasoline and is similar in composition to some volatile light crude oils.

Petroleum is a mixture of a very large number of different hydrocarbons. The four most commonly found categories of molecules are alkanes, cycloalkanes, aromatics, and more complicated chemical compounds such as asphaltenes. Petroleum also contains trace organic compounds of sulfur, nitrogen, oxygen, and metals such as iron, nickel, copper, and vanadium. Each petroleum source has a unique mix of molecules that define its physical and chemical properties, such as color and viscosity. The molecular composition of crude oil varies widely depending on the source. The chemical elements [5] in crude oil can vary as shown in Table 1.1. Table 1.2 shows the percent ranges of the four key hydrocarbons in crude oil [6].

Alkanes – also called paraffins – are saturated hydrocarbons with straight or branched chains containing only carbon and hydrogen. They have the general formula  $C_nH_{2n+2}$ . Examples of alkanes in crude oil are hexane, decane, and 2,2,4-trimethylpentane (iso-octane).

Cycloalkanes – or, naphthene – are saturated hydrocarbons that have one or more carbon rings to which hydrogen atoms are attached. The general formula of naphthene is  $C_nH_{2n}$ . Examples of cycloalkanes are cyclopentane and cyclohexane.

Aromatics are unsaturated hydrocarbons that have one or more planar six-carbon rings called benzene rings to which hydrogen atoms are attached. They have the

**Table 1.1** Chemical elements in crude oil.

Element	Percent
Carbon	83–85
Hydrogen	10–14
Nitrogen	0.1–2.0
Oxygen	0.05–1.5
Sulfur	0.05–6.0
Metals	<0.1

**Table 1.2** Hydrocarbon in crude oil.

Hydrocarbon	Percent
Alkanes	15–60
Naphthenes	30–60
Aromatics	3–30
Asphaltenes	Remaining

general formula  $C_nH_{2n-6}$ . Examples of aromatics are benzene, toluene xylenes, ethylbenzene, 1,2-dimethylbenzene, naphthalene, and biphenyl.

Sulfur compounds in crude oil are typically found as mercaptans such as ethylmercaptan and cyclic sulfides such as tetrahydrothiophen and benzothiophen.

There are two types of nitrogen-based compounds in petroleum. The first type is basic nitrogen molecules that have an extra lone pair of electrons to facilitate reactions. Basic nitrogen compounds are pyridine, quinolone, and phenanthridine. The second type of nitrogen compounds is nonbasic. In this type of nitrogen, the lone pair of electrons with the nitrogen is delocalized in the ring structure making the molecule less reactive. Indole and carbazole are two nonbasic nitrogen compounds.

Some crude oils contain trace organic oxygen compounds such as benzoic acid and phenol.

Metals such as Fe, Ni, Cu, V, Ca, Mg, Hg, As, and Na are generally found in petroleum. Metals can be in the form of organic or inorganic salts. For example, V can be found in an organic porphyrin structure and  $CaCl_2$ ,  $MgCl_2$ , and NaCl suspended or dissolved as entrained water inorganic salts. Metals in petroleum must be removed or neutralized before processing, as they cause corrosion and fouling to refinery equipment and poison of catalysts.

### 1.2.3 Petroleum Refinery

An oil refinery is an essential part of the downstream side of the petroleum industry. Petroleum refineries are very large industrial complexes that involve many

processing units and auxiliary facilities such as utility units and storage tanks. Some modern petroleum refineries process as much as 900 000 barrels per day of crude oil. According to *Oil and Gas Journal*, a total of 636 refineries operated worldwide at the end of 2014 for a total capacity of 87.75 million barrels per day of crude oil. Reliance Industries' Jamnagar Refinery in Gujarat, India, currently is the world's largest oil refinery. Each refinery has its own unique arrangement and combination of refining processes largely determined by the refinery location, desired products, and economic considerations.

Conversion of heavy oils to useful products requires breaking large molecules into smaller ones. The breaking or cracking of large molecules can be accomplished by one or more combinations of heat, pressure, and chemical reaction. In the process, harmful or unwanted compounds such as metals, sulfur, nitrogen, and oxygen are also removed. The conversion of heavy oils into useful products requires many separation and chemical reaction processes. These processes are briefly characterized as follows:

- *Desalination*: This is the first unit in the refinery complex. Salts from crude oil are extracted before it enters the atmospheric distillation unit.
- *Crude oil distillation (atmospheric distillation)*: The desalted crude oil is separated into various fractions for processing in downstream units.
- *Vacuum distillation*: The residue oil from the bottom of the crude oil distillation unit is further distilled at a vacuum pressure well below atmospheric.
- *Naphtha hydrotreater*: The hydrotreater desulfurizes, denitrogenizes, and deoxygenizes naphtha using hydrogen from the atmospheric distillation unit. The naphtha must be treated before sending the stream to the catalytic reformer unit.
- *Catalytic reformer*: The reformer converts the hydrotreated naphtha into reformate, which has a higher content of aromatics and cyclic hydrocarbons. The end products are high-octane gasoline and *para*-xylene aromatics, which is a critical petrochemical in making PET.
- *Distillate hydrotreater*: This unit, similar to the naphtha hydrotreater, removes sulfur, nitrogen, and oxygen from distillates (such as diesel) and other units within the refinery after atmospheric distillation.
- *Fluid catalytic cracker (FCC)*: The FCC process is used to upgrade the heavier, higher boiling-point fractions from the crude oil distillation by converting them into more valuable lighter and lower boiling-point products.
- *Hydrocracker*: The hydrocracker uses hydrogen to upgrade heavy residual oils from the vacuum distillation unit by thermally cracking them into more valuable lighter and lower-viscosity products.
- *Merox*: The Merox process desulfurizes LPG, kerosene, and jet fuel by oxidizing mercaptans to organic disulfides.
- *Coking*: Delayed cokers, fluid cokers, and flexicokers are used to crack very heavy residual oils into gasoline and diesel fuel leaving petroleum coke as a residual product.
- *Alkylation*: Alkylation is a process that uses sulfuric or hydrofluoric acid or an ionic liquid as a catalyst to produce high-octane components for gasoline blending.

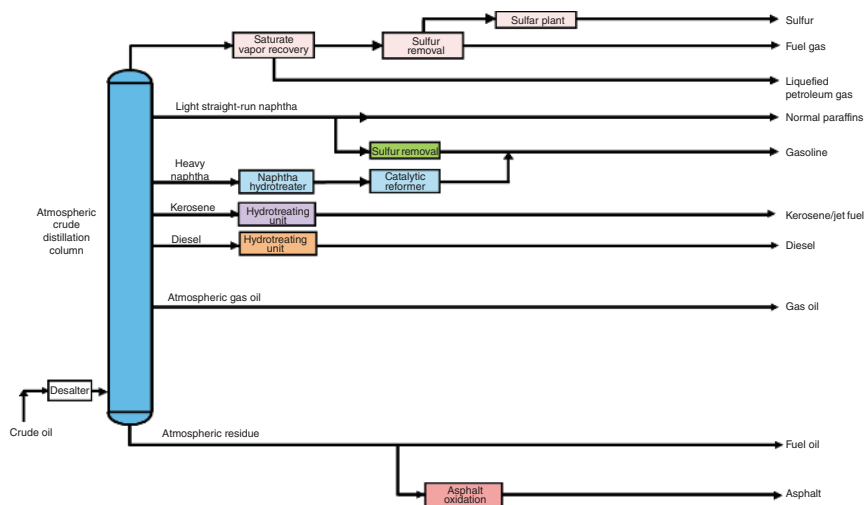

**Figure 1.1** Topping and hydroskimming refinery.

For example, iso-butane and butylenes can be converted into iso-paraffin alkylate, which is a very high-octane gasoline.

- **Dimerization:** Dimerization is used to convert olefins into higher-octane gasoline. For example, butenes are dimerized into isooctene, which is subsequently hydrogenated to form isooctane.
- **Isomerization:** This process converts linear molecules such as normal pentane to higher-octane branched molecules for blending into gasoline. Isomerization units also are used to convert linear molecules such as normal butane into isobutane for use in alkylation units.

Oil refining is the process where crude oil is transformed into more desirable and valuable products using the processes described above. Refineries often are classified by the number and type of process units available for transforming crude oil into petroleum products.

Topping refineries are the least complex refineries and are used to separate the crude oil into its constituent petroleum products by atmospheric distillation; naphtha is produced, but no gasoline. Hydroskimming refineries are also one of the simplest types of refineries used in the petroleum industry and are equipped with atmospheric distillation, naphtha reforming, and additional treating processes to produce gasoline. Important to note, a hydroskimming refinery produces a surplus of fuel with a relatively unattractive price and demand. Figure 1.1 shows schematic topping and hydroskimming refineries.

The next refinery classification in complexity level is a medium-conversion refinery. A medium-conversion refinery is shown in Figure 1.2. To design a medium-conversion refinery, unit operations such as vacuum distillation, thermocracking, fluid catalytic cracking, and asphalt oxidation are added to the hydroskimming refinery. This added level of complexity allows conversion of fuel oil to light distillates and middle distillates.



**Table 1.3** A breakdown of the petroleum products made from a typical barrel of U.S. oil.

Petroleum products	Percent
Gasoline	46
Jet fuel	9
Diesel and other fuel	26
Heavy fuel oil	4
Lubricants	1
Asphalt	3
Other products	11

Source: US Energy Information Administration, 31 May 2018.

derived from petroleum refineries. Depending on the composition of the crude oil and the demands of the market, refineries can produce different types and proportions of petroleum products. Petroleum products are usually grouped into four categories: light distillates (LPG, gasoline, naphtha), middle distillates (kerosene, jet fuel, diesel), heavy distillates, and residuum (heavy fuel oil, lubricating oils, wax, asphalt). The largest share of petroleum products is fuels, which include single or blended combinations of hydrocarbons to provide gasoline, jet fuel, diesel fuel, heating oil, and heavier fuel oils. Heavier fractions also can be used to produce asphalt, tar, paraffin wax, lubricating, and other heavy oils. Table 1.3 summarizes a breakdown of the petroleum products made from a typical barrel of U.S. oil.

Refineries also produce chemicals that are used to produce polymers, detergents, and other useful consumer products. Since petroleum contains sulfur-containing molecules, elemental sulfur is often produced as a petroleum byproduct. Carbon, in the form of petroleum coke, and hydrogen gas also are produced as petroleum byproducts. For example, hydrogen often is used as an essential reactant for other oil refinery processes such as hydrocracking and hydrodesulfurization.

### 1.3 Petrochemical Building Blocks

The industrial use of petrochemicals has focused throughout its history on roughly seven main building blocks, often called intermediates, which are obtained from both natural gas and petroleum processing. These seven basic building blocks are:

- *Ethylene*: Also known as ethene and possessing the formula  $C_2H_4$ , it is a colorless flammable gas. Because it contains only two carbon atoms, it is the simplest carbon-carbon double bond building block.
- *Propylene*: Also known as propene or methyl ethylene, propylene has the formula  $C_3H_6$ . It also is an excellent  $C=C$  double-bond building block allowing unique reactions and functionality because of the presence of both olefinic and aliphatic carbon-carbon bonds.

- **C4 mono- and diolefins:** This grouping is composed of butenes (also called butylenes) having the formula  $C_4H_8$ , and butadiene having the formula  $C_4H_6$ . While we group these building blocks together for simplicity, they are often used for vastly different chemistry purposes and final products.
- **Benzene:** The simplest of the aromatic ring structures having a formula of  $C_6H_6$  makes benzene a very important organic molecule in the petrochemical industry.
- **Toluene:** Also known as toluol, toluene has the same ring structure as benzene but has one methyl group substituted on the ring. Its formula is  $C_7H_8$ .
- **Xylenes:** While strictly defined as the three dimethyl substituted benzene isomers (1,2-, 1,3-, and 1,4-dimethylbenzene), the petrochemical industry often classes ethylbenzene into the same grouping called xylenes. This is because the dimethyl benzenes and ethylbenzene have the same formula ( $C_8H_{10}$ ) and very similar boiling points. The result is that these compounds are nearly always found together in raw material sources.
- **Synthesis gas:** The oddest grouping in the building blocks, synthesis gas is a mixture of  $H_2$  and carbon monoxide (CO) in a molar ratio typically ranging from around 1.0 to slightly higher than 2.0. Synthesis gas is used to produce many final products and intermediates due to the flexible nature of the building blocks.

Chemical structures of these basic building blocks are shown in Figure 1.4.

From these seven building blocks, and adding abundant, readily available chemicals such as air, pure oxygen, or pure nitrogen, the petrochemical industry has built a wide variety of value-added compounds that have become essential to modern society. For example, in a modern automobile, plastics and petrochemical compounds

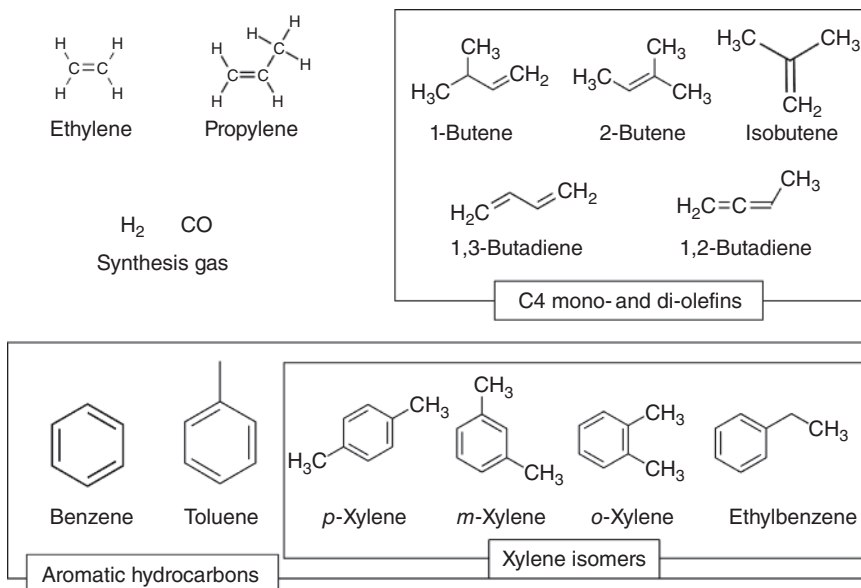

**Figure 1.4** Chemical structure of common petrochemical building blocks.

account for more than 50% of the volume of materials used. Despite this large fraction of the volume, the petrochemical parts make up only about 10% of the vehicle weight [7]. Clearly the trend of replacing automotive parts with lighter-weight pieces based on petrochemicals will have to continue as lighter, more energy-efficient, and electric vehicles become more popular.

The seven building blocks are mostly present as components of raw materials (petroleum, natural gas) described earlier. Indeed, most of the building blocks had been identified in the 1800s as components of these raw materials. For example, Faraday [8] was reportedly the first to successfully isolate and characterize benzene in 1825. However, these compounds were needed to be present in much larger quantities, and isolated as intermediates for subsequent chemical reactions, for them to be of use as building blocks. With petroleum and natural gas as starting materials, the industry began to invent methods to obtain these building blocks in vast quantities.

Today, the unit operations (reactions, separations, heat transfer, etc.), which are combined in systematic ways to make petrochemical building blocks in large quantities, often are referred to as *petrochemical complexes*. Although very few petrochemical complexes are exactly alike, we can categorize these complexes into three basic types.

- **Olefin complexes:** The complexes make predominantly the olefins ethylene, propylene, and butenes. It is the primary technology for the product of olefins in steam cracking [9], but other technologies such as dehydrogenation and methanol to olefins technologies [10, 11] are gaining traction. In a steam cracking-based olefin complex, the primary product is ethylene; the other products are formed in far lower quantities. These complexes will sometimes be “fully integrated” – meaning they have full recovery of propylene, butenes, and even the aromatics formed. Others will recover only the ethylene and propylene and sell the remainder of the liquid products to others for recovery. A sample block-flow diagram for an olefins complex using steam cracking of hydrocarbons is shown in Figure 1.5.
- **Aromatics complexes:** These complexes make mostly aromatics hydrocarbons, and often make most of the product as *para*-xylene for use in the synthesis of purified terephthalic acid, PTA [12]. These complexes usually employ a technology to reform the naphtha cut of petroleum into aromatic rings, and then use a series of technologies to interconvert the aromatic rings into the desired products, with

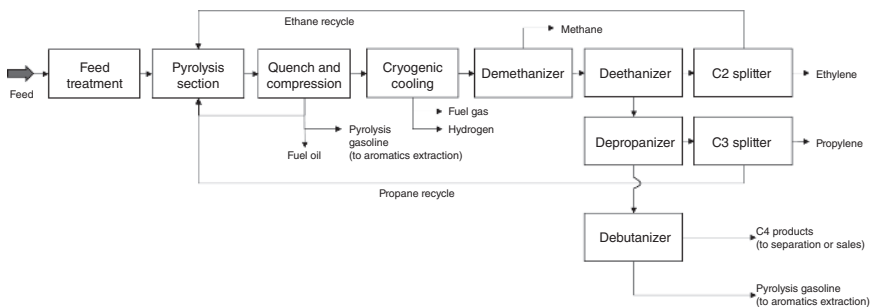

**Figure 1.5** Block flow diagram of typical naphtha-based olefins unit.

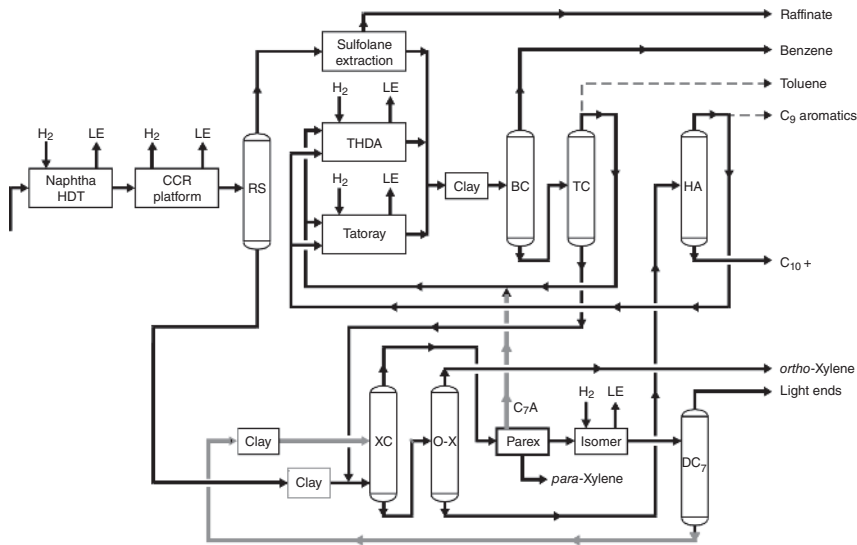

**Figure 1.6** Typical aromatics complex.

*para*-xylene being typically the most desired. A typical plant-flow diagram for an aromatics complex is shown in Figure 1.6.

- Synthesis gas complexes:** In these complexes, coal, natural gas, or some other hydrocarbon source is steam reformed into a synthesis gas mixture ( $H_2$  and  $CO$ ). This synthesis gas then is converted into a variety of different products, including methanol or ammonia by reacting the hydrogen with nitrogen recovered from air. While methanol is a very-large-volume commodity chemical, ammonia production is even larger due to the use of ammonia in agricultural fertilizers. While the types of reformers and the layout vary significantly based on feedstock, product ratios, and reformer technology, a typical layout for a synthesis gas plant making methanol from natural gas is shown in Figure 1.7.

Together, these three types of complexes form most of the conversion of raw materials into the building blocks, which support the petrochemical industry.

Many authors have tried to point to the “birth” of petrochemicals – something which has always resulted in controversy. This is because petrochemicals have existed for as long as our natural resources have existed, but were often masked

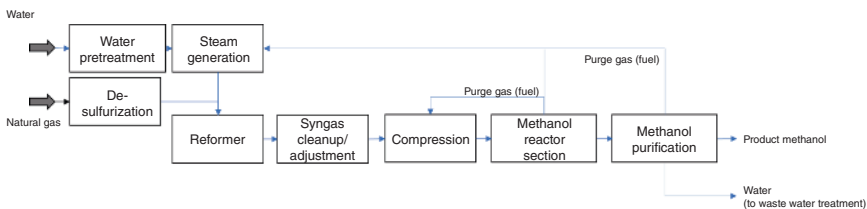

**Figure 1.7** Block flow diagram of typical methanol plant.

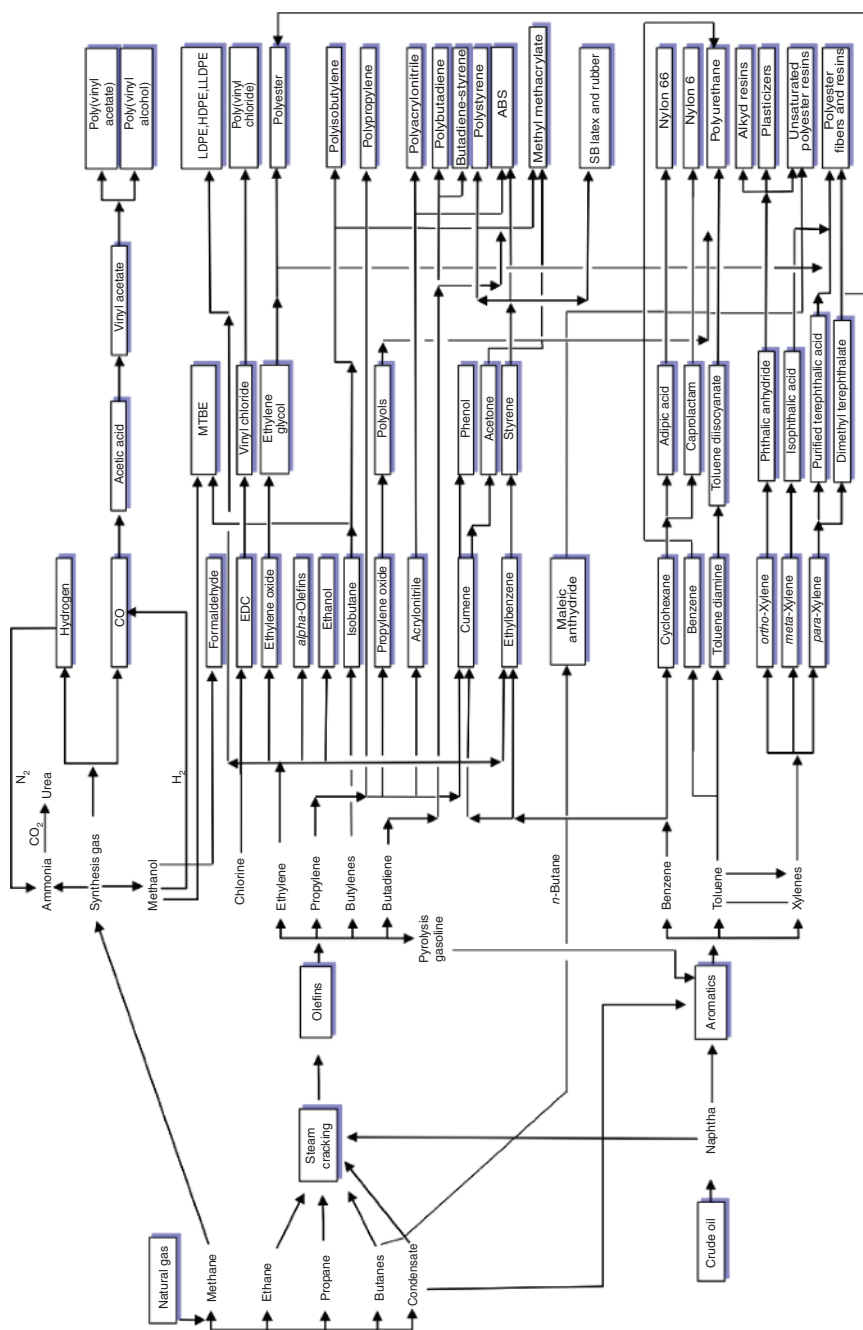
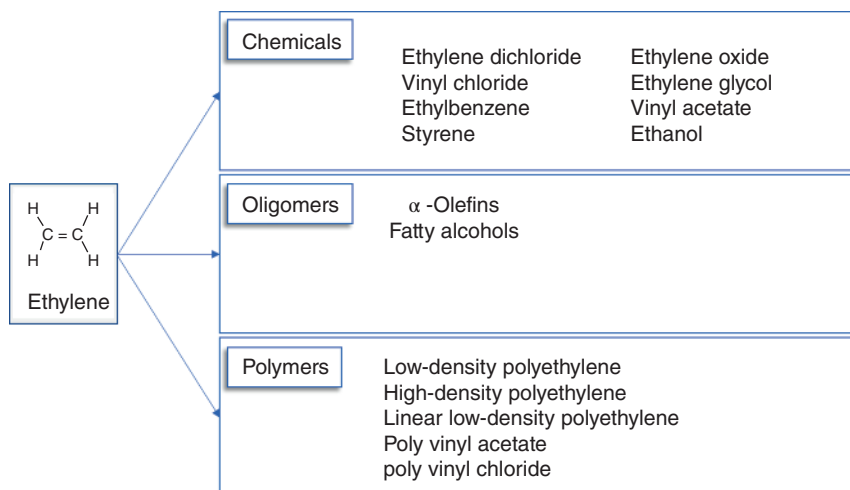

Figure 1.8 Illustrative example of products from building blocks.



**Figure 1.9** Examples of products from ethylene.

or shrouded in the complexity of the complicated mixtures they were contained in as described earlier. However, one of the first commercial complexes built for the large-scale production of a petrochemical was in the early 1900s in West Virginia. With its start in 1927, the Blaine Island plant of the Carbide and Carbon Chemicals Corporation (later known as Union Carbide and recently acquired by Dow Chemical) was the first truly integrated petrochemical plant. It produced predominantly ethylene through a process, which we now call steam cracking of hydrocarbons [13].

For any building block, intermediate or product to be useful, it must have an end use, which adds values for consumers. For example, the largest end use of ethylene (almost 70%) is in the manufacture of polyethylene. Polyethylene is broadly used in food packaging, in engineered polymers, and in many other applications. With such important and growing applications, it is no wonder that the production of ethylene has been growing at slightly higher than GDP (about 1.5× the global GDP growth rate on average from 1990 through 2017 [14]).

One aspect that makes the petrochemical building blocks particularly interesting, however, is the versatility to make multiple different products from the same molecule. This versatility is illustrated in Figure 1.8, which shows the major building blocks and only a few of the primary products, which can be produced from them. For example, the same ethylene molecule used to make polyethylene can also be used to make ethylene glycol, which is used as a coolant, as an ingredient in cosmetics and foodstuffs, and as a key component of polyester fibers and bottles.

Indeed, dozens of other petrochemicals, fine and specialty products can be derived from ethylene; the major products and further intermediates produced by ethylene are shown in Figure 1.9. The same is true for the other olefins, and for most of the other building blocks, making the evaluation petrochemical markets and economics a particularly rich and exciting field. We will discuss this in depth in Chapter 2.

## References

- 1 Background. Naturalgas.org (archived from the original on 9 July 2014).
- 2 U.S. Energy Information Administration. Eia.gov (retrieved on 6 August 2013).
- 3 Beschloss, M. U.S. now World's leading natural gas producer. *Desert Sun* (retrieved on 4 November 2014).
- 4 Organic origins of petroleum. US Geological Survey (archived on 27 May 2010).
- 5 Speight, J.G. (1999). *The chemistry and technology of petroleum* (3rd ed., rev. and expanded ed.). New York: Marcel Dekker. pp. 215–216, 543. ISBN: 0824702174. OCLC 44958948.
- 6 Hyne, N.J. (2001). *Nontechnical Guide to Petroleum Geology, Exploration, Drilling, and Production*, 2e, 1–4. Tulsa, OK: Penn Well Corp. ISBN: 087814823X. OCLC 49853640.
- 7 American Chemistry Council, Economics & Statistics Department (July 2018). *Plastics and Polymer Composites in Light Vehicles*.
- 8 Faraday, M. (1825). On new compounds of carbon and hydrogen, and on certain other products obtained during the decomposition of oil by heat. *Philosophical Transactions of the Royal Society* 115: 440–466.
- 9 (2017). *CEH: Ethylene*, Chemical Economics Handbook Series. IHS Markit.
- 10 IHS Markit Note (11 April 2018). The tight link between methanol and olefins. <https://cdn.ihs.com/www/blog/20180411-Chem-MTO-Infographic.pdf> (accessed 03 September 2020).
- 11 IHS Markit: Methanol demand growth driven by methanol-to-olefins, China demand. *Hydrocarbon Process* (13 June 2017). <https://www.hydrocarbonprocessing.com/news/2017/06/ihs-markit-methanol-demand-growth-driven-by-methanol-to-olefins-china-demand>.
- 12 (2018). *CEH: Mixed Xylenes*, Chemical Economics Handbook Series. IHS Markit.
- 13 *Modern life made possible*. West Virginia Department of Commerce, Press Center. [https://urethaneblog.typepad.com/my\\_weblog/2014/03/the-first-ethylene-cracker-in-the-us-was-in-wv.html](https://urethaneblog.typepad.com/my_weblog/2014/03/the-first-ethylene-cracker-in-the-us-was-in-wv.html).
- 14 Eskew, B. (2018). US petrochemicals: the growing importance of export markets. *IHS Markit Presentation at EIA Energy Conference* (04 June 2018). [https://www.eia.gov/conference/2018/pdf/presentations/blake\\_eskew.pdf](https://www.eia.gov/conference/2018/pdf/presentations/blake_eskew.pdf).